

CEILING SYSTEMS

[Between us, ideas become reality.™]

AXIOM™ Perimeter Trim



Armstrong

AXIOM™

Design, on the edge.

Knife Edge AXIOM™ with SUPRAFINE grid and ULTIMA® panel

AXIOM Perimeter Trim can give your next space a unique, crisp feel. The AXIOM family offers dramatic visuals with a variety of flat vertical trims and design profiles.

Armstrong AXIOM is a custom perimeter trim system designed for use with any Armstrong acoustical or plasterboard suspension system.

Knife Edge AXIOM is a one-of-a-kind profile with a thin, weightless look – the perfect alternative to a traditional, flat vertical profile.

AXIOM is made from extruded aluminium and offers precise detailing and quality that you can't get with steel. Pre-mitred corners make

installation easy for custom geometric designs like rectangles, squares or serrated edges.

Selecting the right visual around the ceiling perimeter is as important as choosing the right frame for a work of art. AXIOM is more than a solution for light coves and transitions. Used straight, subtle or sharp, the refined look of the prefinished extruded aluminium is functional and visionary.

With three unique designs to choose from, Classic, Knife Edge and Profiled, AXIOM Perimeter Trims provide "simple to install" and cost effective perimeter solutions to any Armstrong ceiling system.

Knife Edge AXIOM™



Get the creative edge with Knife Edge AXIOM from Armstrong. Knife Edge AXIOM is a sharp contrast to traditional vertical profiles. The sleek edge detail gives floating ceilings a thin, weightless feel to make a dramatic visual statement.

Like all AXIOM profiles, Knife Edge is designed for seamless integration with plasterboard or any Armstrong ceiling system, lay-in or tegular.

Knife Edge AXIOM

- Unique profile provides a refined alternative to traditional flat vertical trims
 - **Knife Edge AXIOM** for traditional acoustical lay-in and tegular panels, as well as plasterboard
- Standard prefinished, 300mm x 90-degree factory welded inside and outside corners
- AXIOM sections are produced in standard 3,000mm lengths, however, can be ordered from the factory in custom sizes ranging from 600 to 3,000mm in length

▲ Knife Edge AXIOM™ with SUPRAFINE grid and ULTIMA® panel

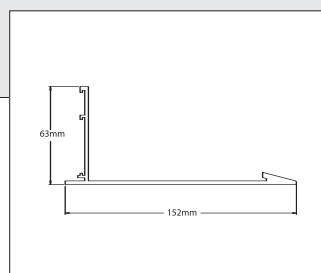

Knife Edge profile



Standard factory welded corners for Knife Edge

When creating a new space or enhancing an existing one, Classic profiles offer you the tools to visually define a ceiling. The extruded aluminum process provides crisp, refined detail in every trim. And with four different profile heights, there are a wide range of possibilities.

Classic AXIOM also provides easy solutions for design challenges like ceiling height transitions, soffits, and light covers as well as air supply and return functions. Whether your needs are form or function, you'll add aesthetic value and increase the visual effect of your design.

Classic AXIOM

- Design flexibility
- Four profile heights available: 100mm, 150mm, 250mm and 300mm
- Finely articulated plasterboard trim with beaded edge integrates with all AXIOM profiles for pre-engineered plasterboard transition
- Standard Prefinished, 300mm x 90-degree factory mitered inside and outside corners
- AXIOM sections are produced in standard 3,000mm lengths, however, can be ordered from the factory in custom sizes ranging from 600 to 3,000mm in length



▲ Classic AXIOM™ with SUPRAFINE grid and ULTIMA® panels



Field cut or factory mitered corners. Field assembled using Axiom Splice Plate.

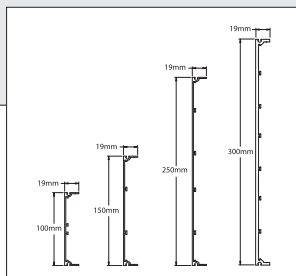

Classic AXIOM Trim profiles

Profiled AXIOM™



▲ Profiled AXIOM™ with SUPRAFINE grid and ULTIMA® panel

Let your vision take shape with the articulate design of Profiled AXIOM. The two distinctive contours add a touch of refinement to any light cove, pocket, floating ceiling or large scale coffer. The convex and concave profiles provide a uniquely coordinated, elegant look. Profiled AXIOM is crafted from extruded aluminium for crisp edge detailing you simply can't get with steel or traditional plasterboard framing and finishing.

Profiled AXIOM

- Finely articulated plasterboard trim with beaded edge integrates with both AXIOM profiles for pre-engineered plasterboard transition
- Standard Prefinished, 300mm x 90-degree factory welded inside and outside corners
- AXIOM sections are produced in standard 3,000mm lengths, however, can be ordered from the factory in custom sizes ranging from 600 to 3,000mm in length

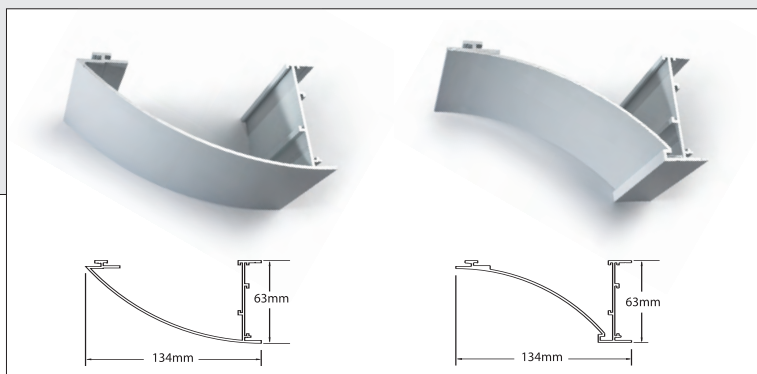

Profiled AXIOM
Convex

Profiled AXIOM
Concave

AXIOM Perimeter Trim Assembly

Knife Edge AXIOM™

Knife Edge AXIOM™ with Armstrong panels or plasterboard



Knife Edge AXIOM with Tegular Edge panel

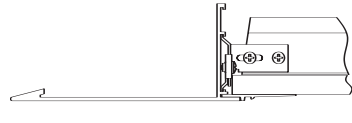

Knife Edge AXIOM with Plasterboard Trim (AXDWT)

T-Bar Connector Clip

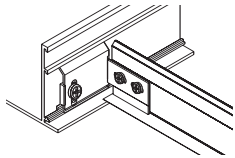

T-Bar Connector Clip (AXTBC) with Knife Edge AXIOM

Hanging Clip

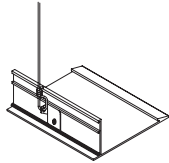

Hanging Clip (AX2HGC)

Splice Plate / Alignment Clip

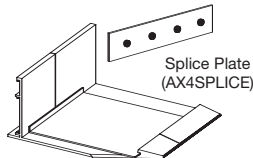

Splice Plate (AX4SPLICE)
Knife Edge Alignment Plate (AXKEALIGN)

Classic AXIOM™

Classic AXIOM™ with Armstrong panels or plasterboard

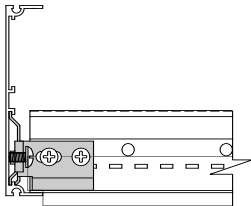

Classic AXIOM with Tegular Edge panel

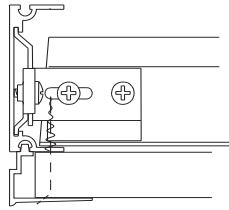

Classic AXIOM with Plasterboard Trim (AXBT)

← This section does not print
Page Edge

T-Bar Connector Clip

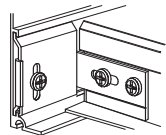

T-Bar Connector Clip (AXTBC) with Classic AXIOM

Corner Splice Plate

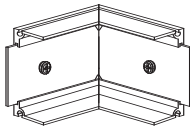

Field mitre cut corner with Splice Plate (AXSPLICE)

Splice Plate

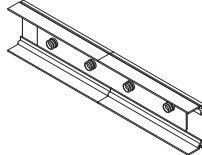

Splice Plate (AX4SPLICE)

Profiled AXIOM™

Profiled AXIOM™ with Armstrong panels or plasterboard

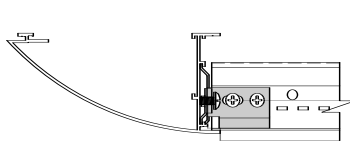

Profiled AXIOM with Tegular Edge panel

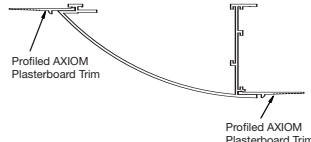

Profiled AXIOM with Plasterboard Trim (AXDWT)

T-Bar Connector Clip

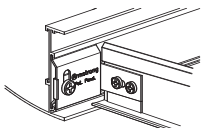

T-Bar Connector Clip (AXTBC) with Profiled AXIOM

Splice Plate / Alignment Clip

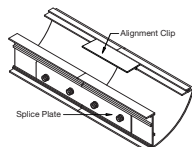

Alignment Clip and Splice Plate (AXALIGN and AX4SPLICE)

This section does not print
Page Edge →



KNIFE EDGE



CLASSIC



PROFILED

Physical Data

Material

Trim Channel: Extruded aluminium, alloy 6063

Hanging Clip: Galvanised steel

T-Bar Connection Clip: Galvanised steel

Splice Plate: Galvanised steel

Colours

Coordinate with Armstrong Global White ceiling and suspension systems. Custom colours are available upon request based on minimum quantity

Surface Finish

Durable polyester powdercoat

Cross Tee/Main Beam Interface

Flush fit

End Detail

Splice Plate and set screws

Typical Applications

Retail, Hospitality (clubs, restaurants, hotels)

Offices (reception areas, lobbies, boardrooms), Healthcare, Education

Warranty

10 year limited warranty; 15 year warranty when used in conjunction with Armstrong suspension system and ceiling panels

Accessories

Refer overleaf

CEILING SYSTEMS

[Between us, ideas become reality.™]

Armstrong, the Global Leader in Acoustic Ceilings

NSW

Armstrong World Industries Pty. Ltd.
Unit 36, Slough Business Park,
Holker Street, Silverwater NSW 2128
Telephone (02) 9748 1588
Facsimile (02) 9748 7244

VIC/TAS

Armstrong World Industries Pty. Ltd.
29-39 Mills Road,
Braeside VIC 3195
Telephone (03) 9580 9633
Facsimile (03) 9587 5139

QLD/NT

Armstrong World Industries Pty. Ltd.
40 Fox Road,
Acacia Ridge QLD 4110
Telephone (07) 3272 0533
Facsimile (07) 3272 0690

SA

Ceiling System Supplies Pty. Ltd.
162 Grand Junction Road,
Blair Athol SA 5084
Telephone (08) 8349 7171
Facsimile (08) 8349 7242

WA

Ceiling Manufacturers of Australia Pty. Ltd.
5 Irvine Street,
Bayswater WA 6053
Telephone (08) 9271 0777
Facsimile (08) 9272 2801

New Zealand

Forman Building Systems Ltd.
PO Box 12349,
Penrose, Auckland
Telephone 64-9-276 4000
Facsimile 64-9-276 4141

www.armstrong-aust.com.au

